

## THE CLASSIC

The essence of yesteryear is captured in the Classic – the modern pole with a touch of nostalgia. The availability of height above grade from 5'-31' enables the designer to adopt an integrated theme through an entire development. The Coachman is common in intimate settings while the Highwayman and Roadway have a splendid effect on arterial roads or commercial areas. The Classic is also available as a lighted or nonlighted bollard.

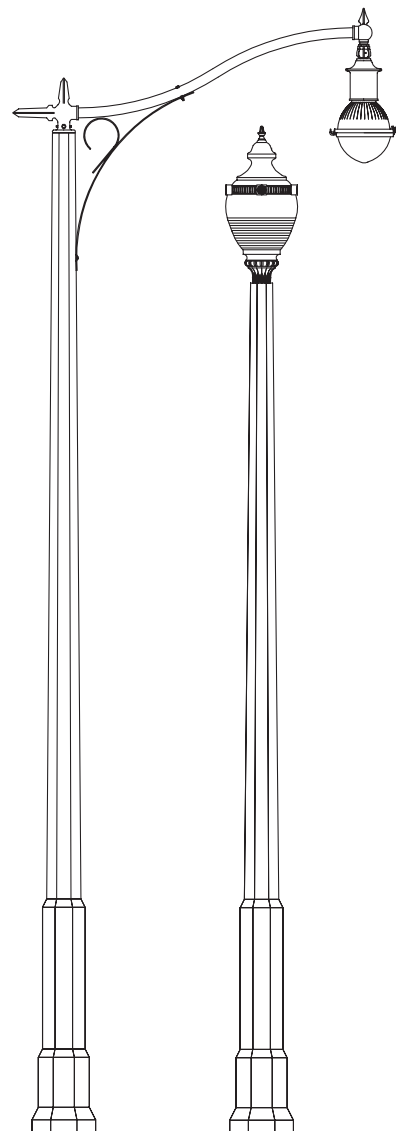

## Specification Details\*

Description	Catalog Number	"A" Pole Height Above Grade	"D" Tip Dimension	"C" Stepped Section Height	"E" Flare	"B" Direct Burial Length & "F" Dia.	Pole Weight Direct Burial	Pole Weight Base Plate
Coachman	12' KCC12	12' 0"	4 1/2"	4' 6"	14"	4' 7" x 8 1/4"	975 lbs	800 lbs
	15' KCC15	15' 0"	4"	4' 6"	14"	4' 7" x 8 1/4"	1050 lbs	865 lbs
Highwayman	18' KCH18	18' 0"	5 1/8"	4' 7"	15 5/16"	5' 0" x 9 1/4"	1100 lbs	920 lbs
	20' KCH20	20' 0"	4 3/4"	4' 7"	15 5/16"	5' 0" x 9 1/4"	1200 lbs	1020 lbs
	22' KCH22	22' 0"	5 3/8"	4' 7"	16"	5' 0" x 10"	1425 lbs	1225 lbs
	25' KCH25	25' 0"	4 3/4"	4' 7"	16"	5' 0" x 10"	1600 lbs	1400 lbs
Roadway	27' KCH27.5	27' 6"	4 1/2"	4' 7"	16"	5' 0" x 10"	1700 lbs	1500 lbs
	31' KCR31.5	31' 4"	5 1/8"	5' 5"	19"	7' 0" x 12"	2550 lbs	2200 lbs

\* For bollard catalog information please see the bollard section in the King Luminaire catalog or visit our website at [www.StressCreteGroup.com](http://www.StressCreteGroup.com)

## How to Catalog for Classic Concrete Pole

Pole Style	Finish	Footing Details	Coating
KCC KCH KCR	E – Etched Finish S – Polished Finish	DB – Direct Buried FBP – Flush Baseplate SBP – Stub Baseplate	NA – Non Acrylic A – Acrylic AG – Anti Graffiti Coating***
<b>KCR</b> <b>31.5'</b>	<b>E</b> <b>40</b>	<b>DB</b> <b>140 30/30</b>	<b>GFI</b> <b>NA</b>
<b>Height</b> 5' - 31'4"	<b>Color**</b> 10 – Midnight Lace 11 – Eclipse Black 30 – Salt & Pepper 40 – Pearl Gray 90 – Saluki bronze	<b>Tenon (Post Top Mount)</b> Specify Tenon Size For example 140 30/30 = 2 7/8" OD & 3" long	<b>Options*</b> DR – Duplex Receptacle GFI – Ground Fault Duplex Receptacle SR – 1 Outlet LRN – Ladder Rest BPC – Base Plate Cover AB – Anchor Bolts BA – Banner Arms FH – Flag Holders

\* Consult website for full listings. \*\* See decor colors on page 2 for full selection of colors.  
\*\*\*Anti Graffiti Coating is extra, consult factory for more details.

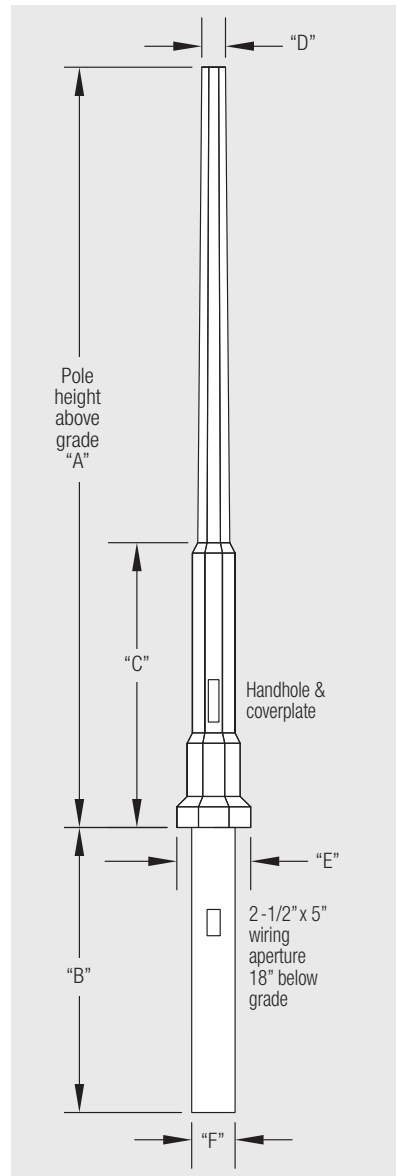

## Footing Details

### Direct Buried

(Simple and Cost Effective)

1. Auger the setting hole.
2. Set pole in hole and plumb straight.
3. Backfill\* with required backfill tamping every 4" to 6".

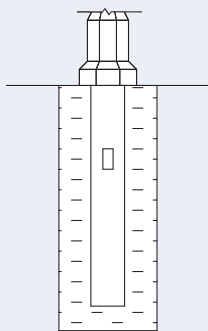

### Baseplate Option 1: FBP

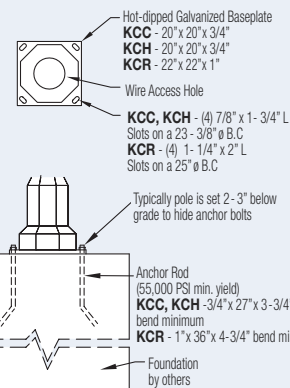

### Baseplate Option 2: SBP

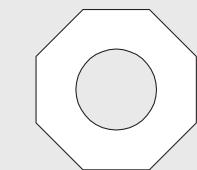
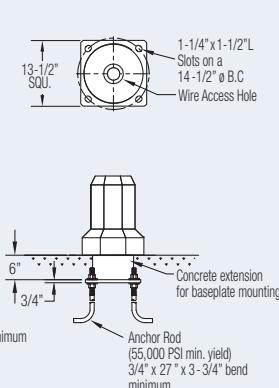

Typical Pole Cross Section

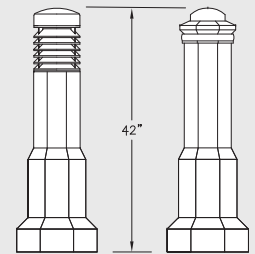

Lighted Bollard    Nonlighted Bollard

\*Generally the excavated material can be used for backfill, in some situations better backfill may be required.