



K582 PILLAR STRUT - LED

As part of the SKYLINE Series, the straight clean lines of the K582 Pillar Strut is what make it stand out. When teamed with the pyramid spinning, it provides a contemporary, low maintenance alternative to a traditional four sided lantern.



King Luminaire

PRODUCT SPECIFICATIONS

LED ENGINE

Light engine shall include an array of Cree X-Series high power LEDs (light emitting diodes). The emitters shall be mounted to a metal core circuit board using SMT technology. The LEDs and circuit boards shall then be mounted to a high performance heat sink which is vented to the outside ambient air to provide dynamic airflow for cooling the system.

OPTICS

External light control shall consist of high precision refractive lenses mounted above the LED emitter arrays in such a way to achieve optimum uplight control. The lenses shall also control horizontal light distribution so that Type II, III, IV or V IESNA distribution patterns are achieved.

LUMINAIRE CONSTRUCTION

All K582 Pillar Strut cast components shall consist of heavy cast aluminum. The main body, or capital, acts as an enclosure for the driver assembly and is of adequate thickness to give sufficient structural rigidity. The capital shall have an opening at the base of the tenon body to allow the luminaire to be mounted to a tenon of 3-1/2" maximum diameter. The luminaire shall be locked in place by means of heavy duty, stainless steel set-screws.

There shall be 2, 3 or 4 cast aluminum decorative pillar struts that are mechanically attached by stainless steel screws to the capital (bottom) and cast aluminum heat sink LED mounting plate (top). The outer body of the fixture is comprised of a one-piece decorative spinning that completes the overall architectural appearance of the luminaire.

DRIVER

The LED universal dimmable driver will be class 2 and capable of 120 - 277V or 347 - 480V input voltage, greater than 0.9 power factor, less than 20% total harmonic distortion. The case temperature of the driver can range from -40°C up to 70°C. Each LED system comes with a standard surge protection designed

to withstand up to 20kV/10kA of transient line surge as per IEEE C62.41.2 C High. An in-line ferrite choke is utilized to provide protection against EFT's. The driver assembly will be mounted on a heavy duty fabricated galvanized steel mounting bracket. Dimming capable using 1-10vdc (10% to 100%), 10v PWM, or resistance.

PHOTOMETRICS

Fixtures are tested to IESNA LM79 specifications. These reports are available upon request.

CHROMATICITY

High output LEDs come standard at 3000K & 4000K (+/- 300K) with a minimum nominal 70 CRI. Additional CCT emitters are available upon request.

LUMEN MAINTENANCE

Reported (TM21) and Calculated (L70) reports are available upon request with a minimum calculated value of 100,000 hrs.

WIRING

All internal wiring and connections shall be completed so that it will be necessary only to attach the incoming supply connectors to Mate-N-Lok connectors. Mate-N-Lok shall be certified for 600V operation. Internal wire connectors shall be crimp connector only and rated at 1000V and 150°C. All wiring to be CSA certified and/or UL listed, type SFF-2, SEWF-2, or SEW-2 No. 14 gauge, 150°C, 600V, and color coded for the required voltage.

THERMALS

Fixtures tested to DOE sanctioned standards to determine the maximum in-situ solder-point or junction-point temperatures of the LED emitters. This report is available upon request.

FINISH

Housing is finished with a 13 step KingCoat™ SuperDurable polyester TGIC powder coat. Standard colors include strobe white, brown metal, marina blue, gate gray, Chicago bronze, standard gold, standard black, federal green and rain forest. Please see our website for a complete list

of colors. RAL and custom color matches are available.

MISCELLANEOUS

All exterior hardware and fasteners, wholly or partly exposed, shall be stainless steel alloy. All internal fasteners are stainless steel or zinc coated steel. All remaining internal hardware is stainless steel, aluminum alloy, or zinc coated steel.

WARRANTY

The K582 Pillar Strut LED luminaire comes with a 7 year limited warranty.

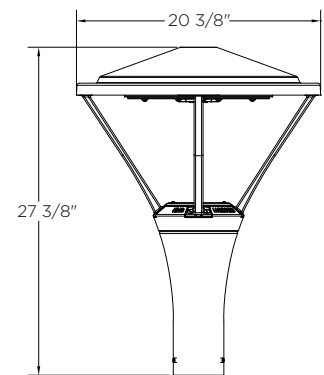

CERTIFICATION:

CSA US Listed
Suitable for wet locations
ISO 9001
IP66
ARRA Compliant
LM79 / LM80 Compliant
IDA Certified*

DRIVER INFO:

>0.9 Power Factor
<20% Total Harmonic Distortion
120 - 277V & 347 - 480V
-40°C Min. Case Temperature
70°C Max. Case Temperature
Surge Protection: ANSI C136.2
extreme level 20kV/10kA
Dimming Capable: 1-10vdc

EPA:

0.52 sq. ft.

FIXTURE WEIGHT:

37 lbs



*IDA Certification applicable for maximum 3000K CCT. Glass lenses do not apply.



Not all product variations listed on this page are DLC qualified. Visit www.designlights.org/search to confirm qualification. 08-11-2021

SPINNING OPTIONS



HARBOR

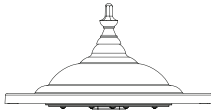

TRUMP

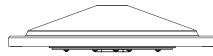

PYRAMID



CONTOUR



NO SPINNING

STRUT OPTIONS

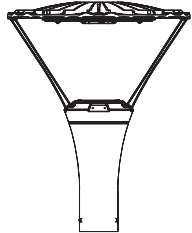

2 STRUT

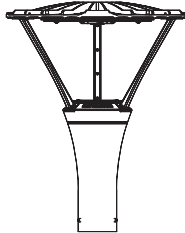

3 STRUT

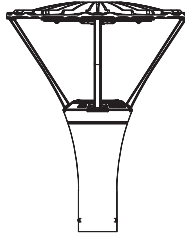

4 STRUT

PHOTO RECEPTACLE

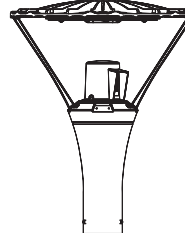

PR

FINIAL OPTIONS

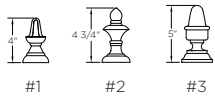

#1

#2

#3

HOW TO ORDER

